

**KICKOFF CRAFT:  
ZEBRA PAPER CRAFT**

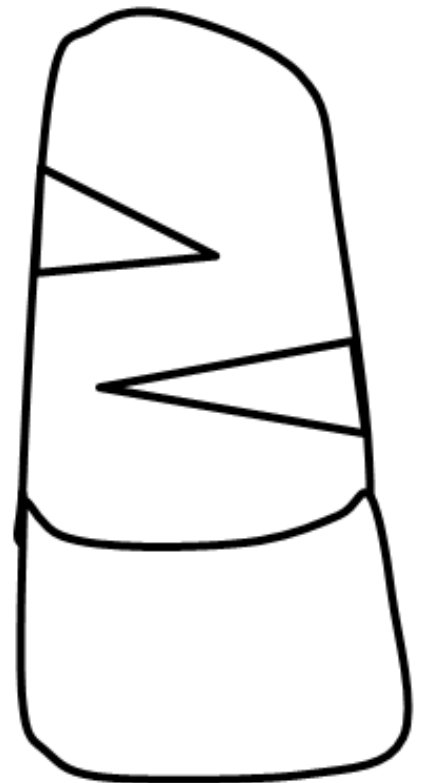

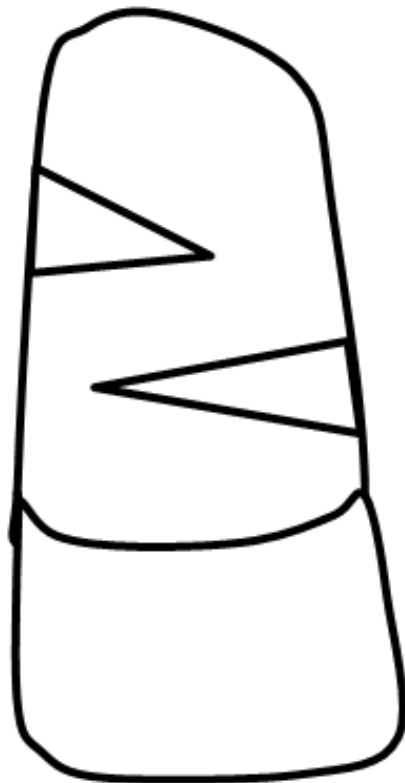

**KICKOFF CRAFT:  
ZEBRA PAPER CRAFT**

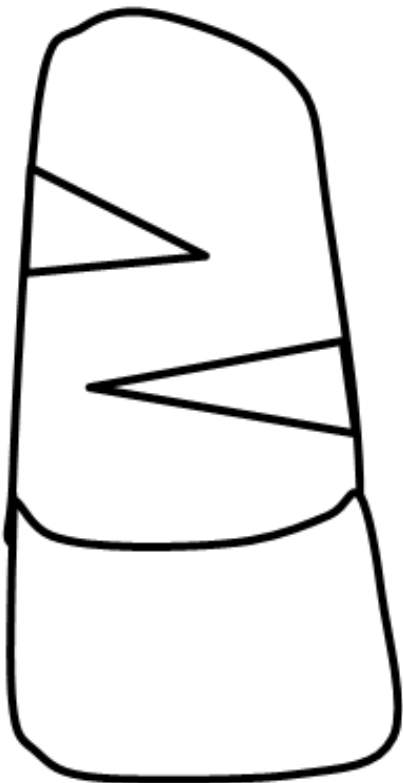
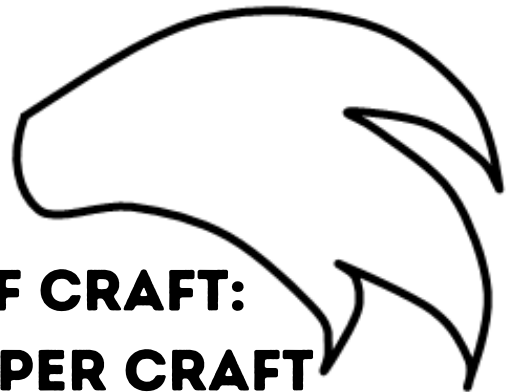
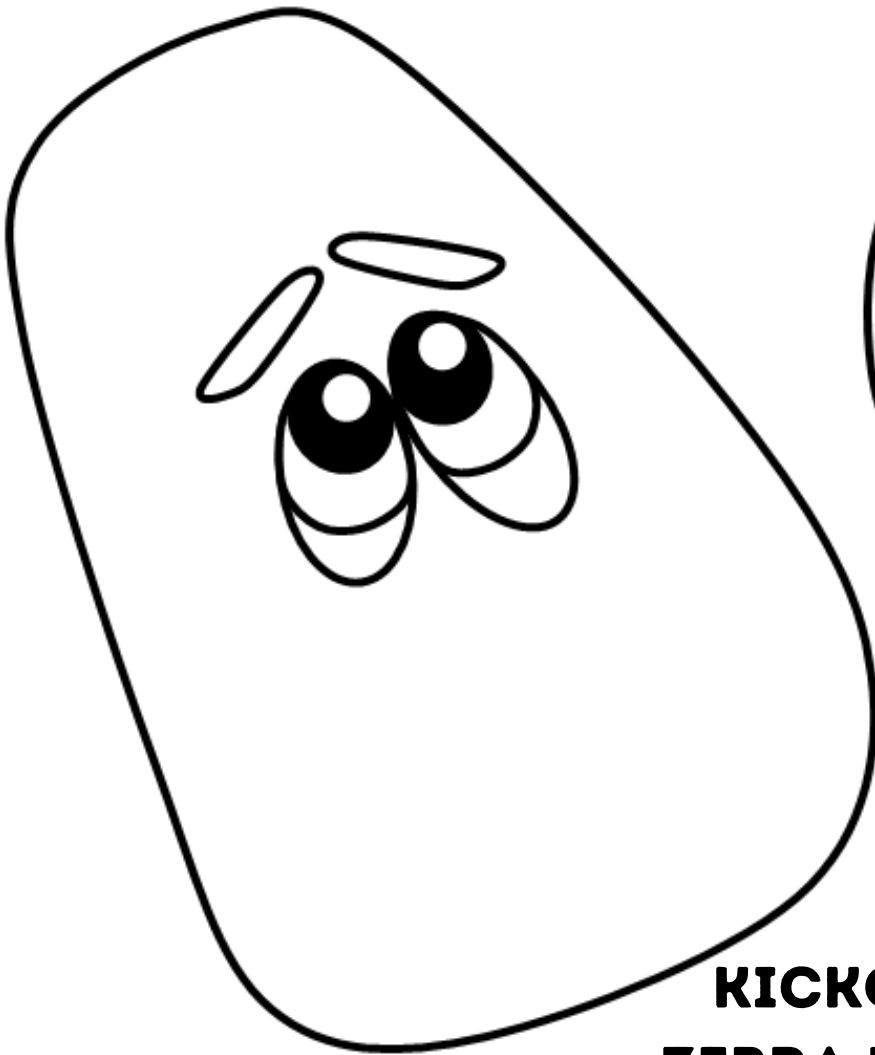
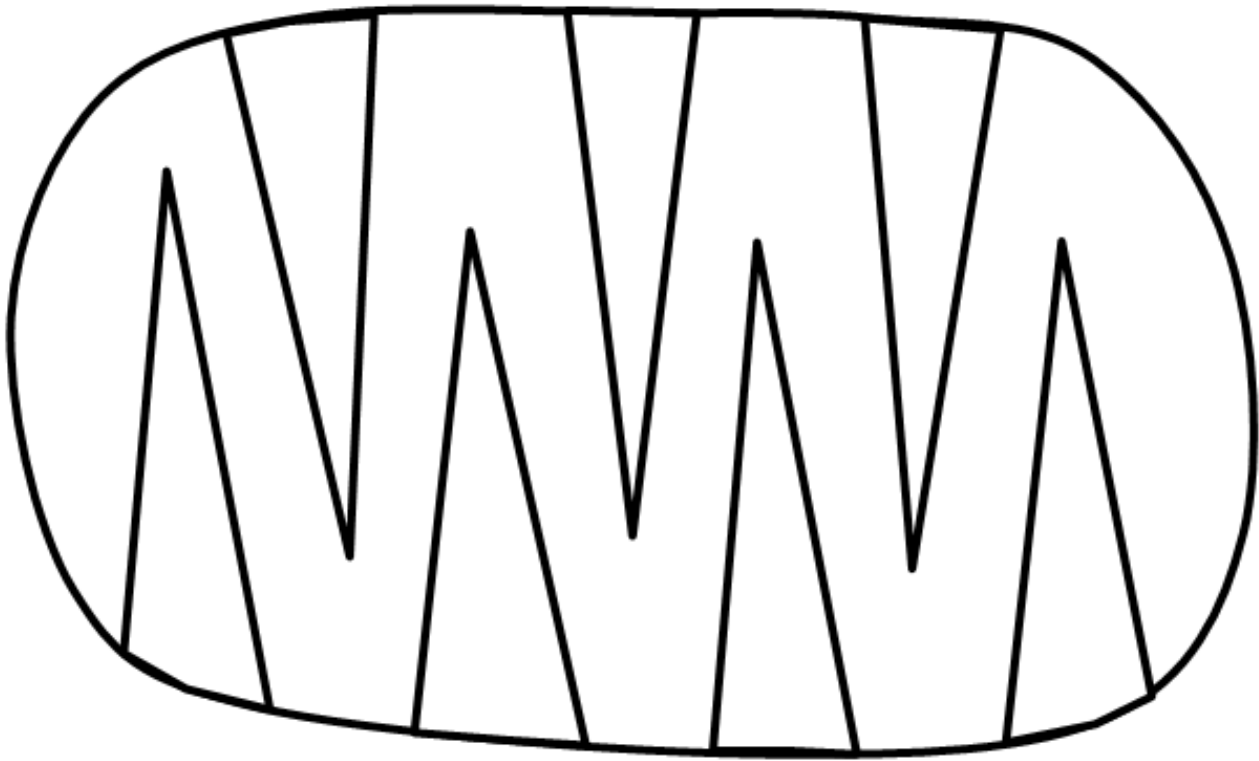
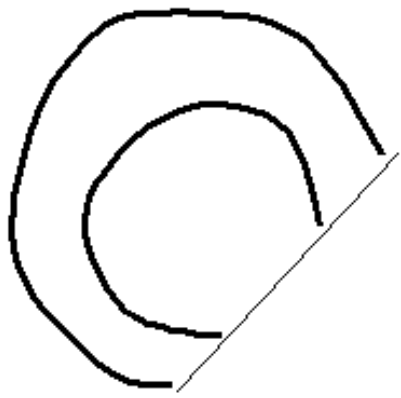

Glue ears, eyes and nose onto front of flap

flap=mouth

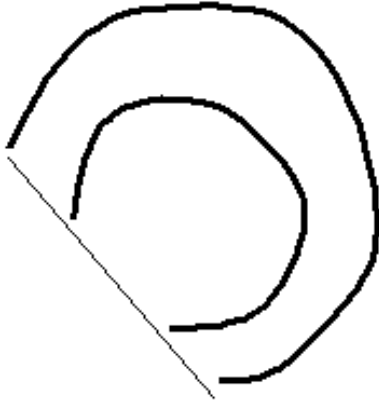

## WEEK # 1 CRAFT: LION PAPERBAG PUPPET

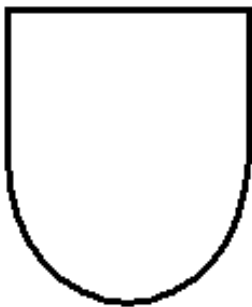

Glue tongue under flap so you cannot see it when flap is closed.

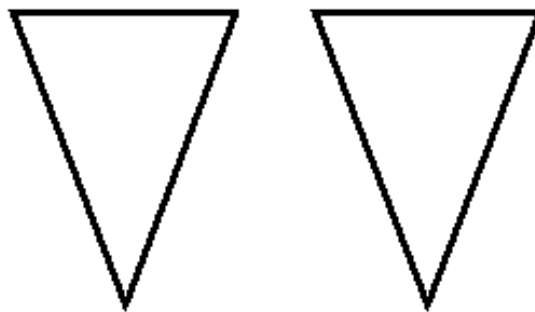

Glue teeth under flap so they are visible when flap is closed.



# WEEK # 1 CRAFT: LION PAPERBAG PUPPET

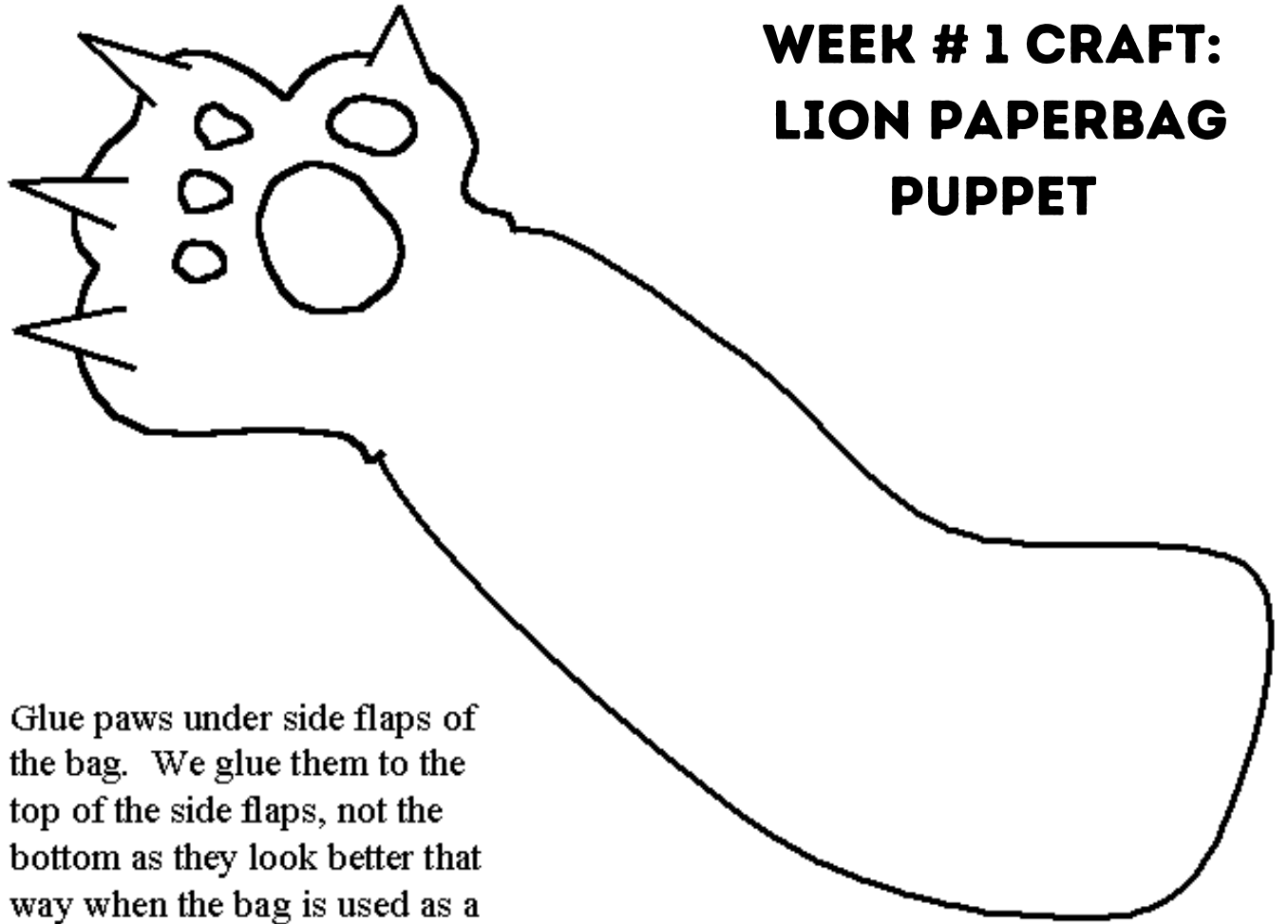

Glue paws under side flaps of the bag. We glue them to the top of the side flaps, not the bottom as they look better that way when the bag is used as a puppet.

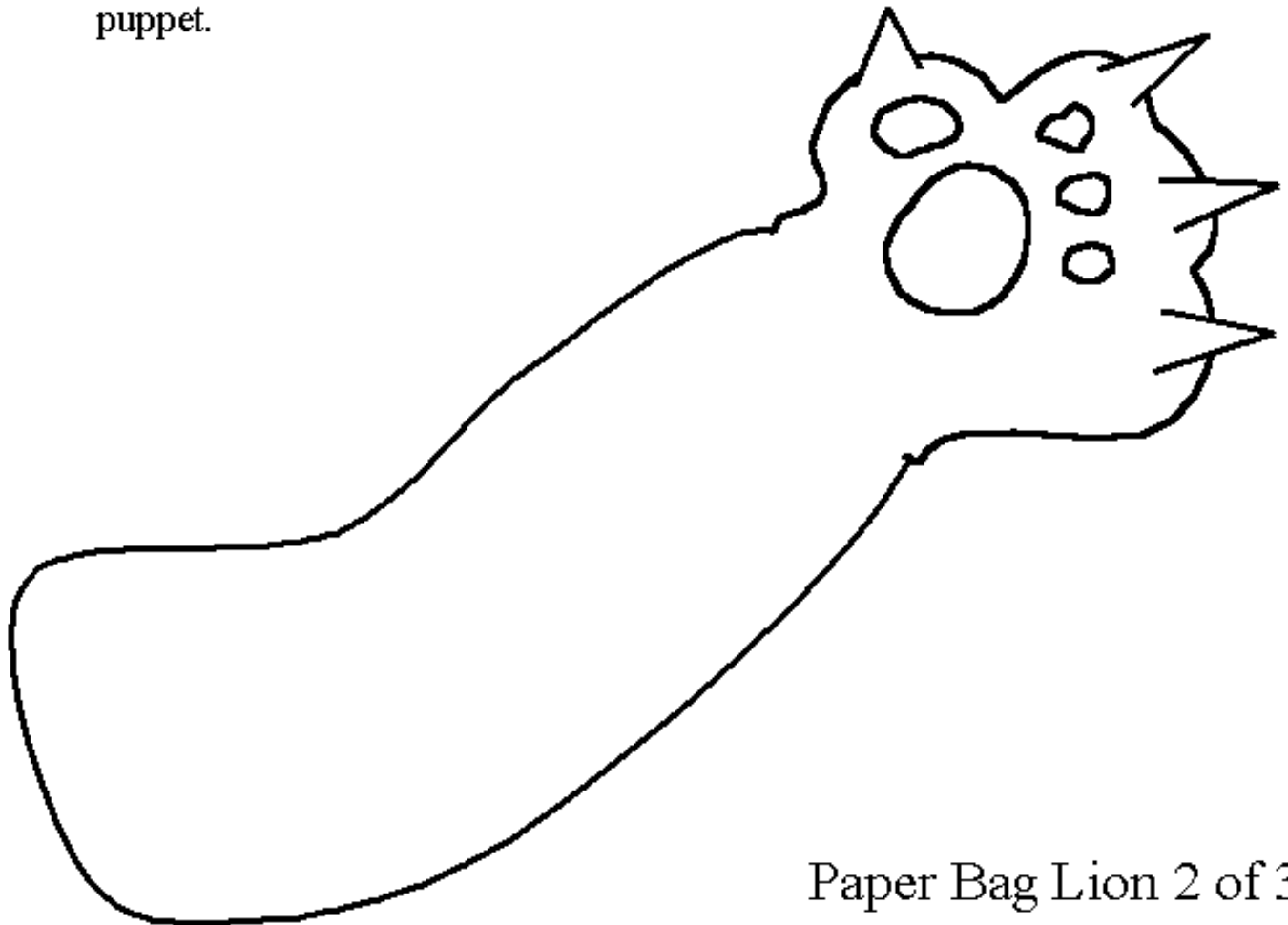

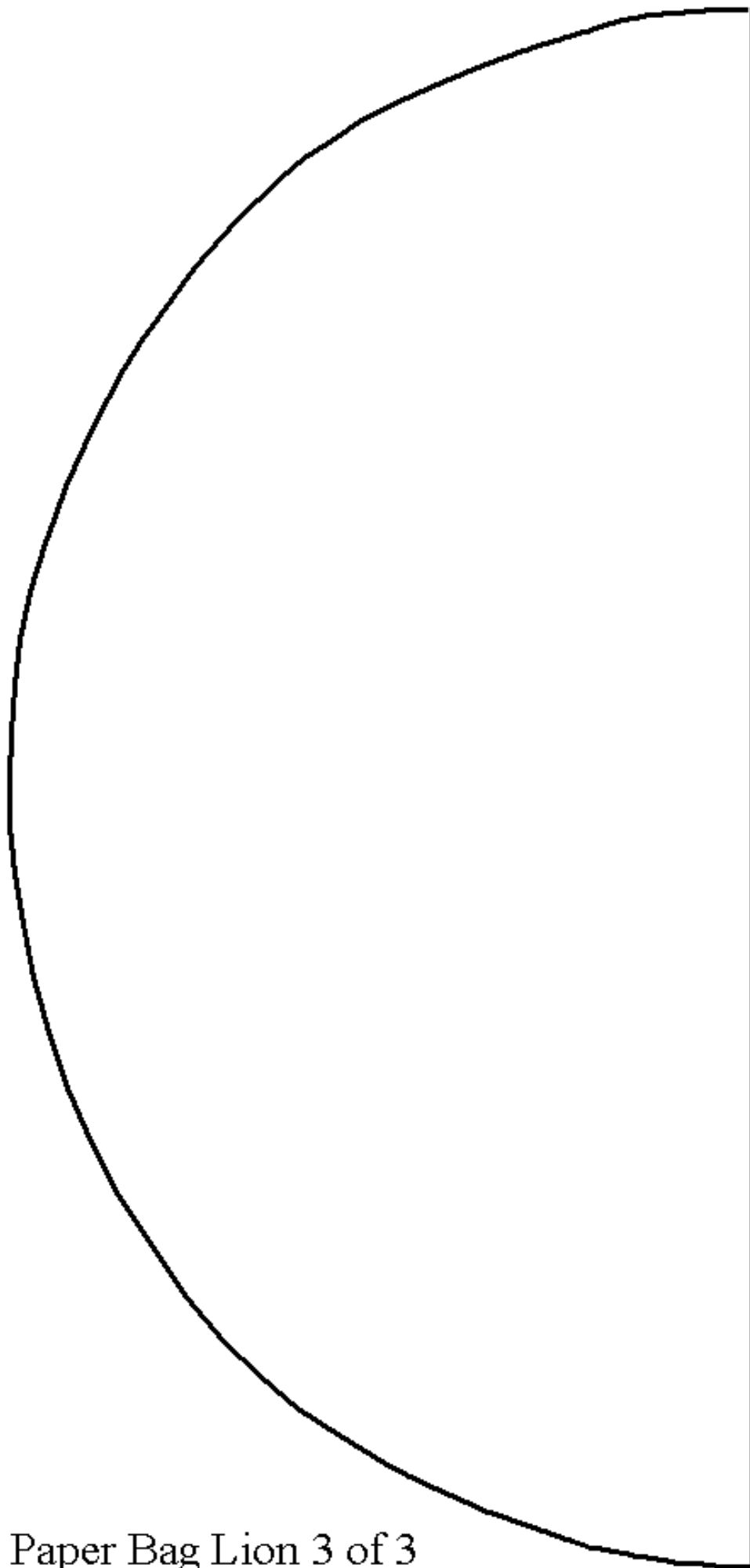

Print twice (the mane)

One goes behind the bag and the other goes under the flap  
(BEFORE) you glue on the tongue

To spruce it up, cut a fringe all around with scissors and curl with a pencil.

## **WEEK # 1 CRAFT: LION PAPERBAG PUPPET**

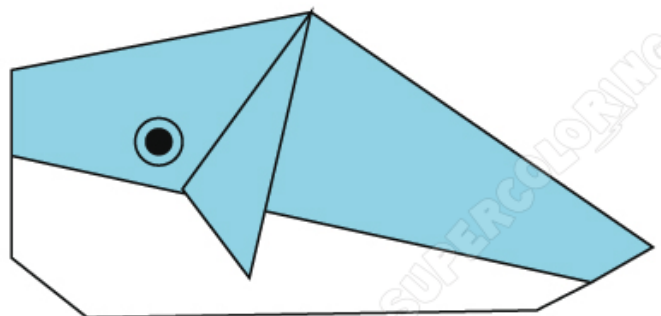
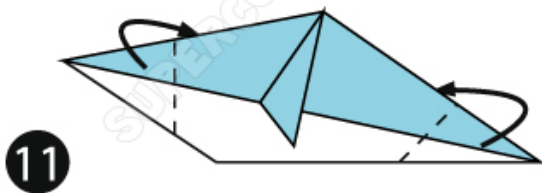
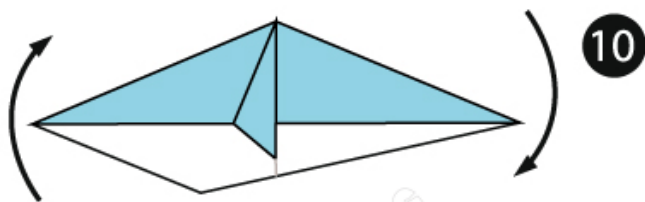
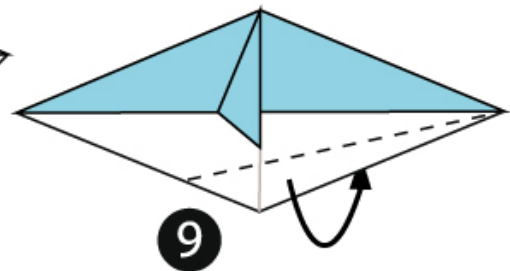
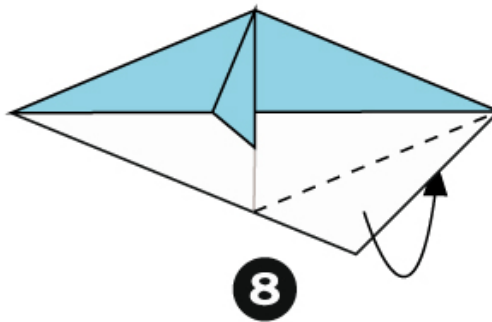
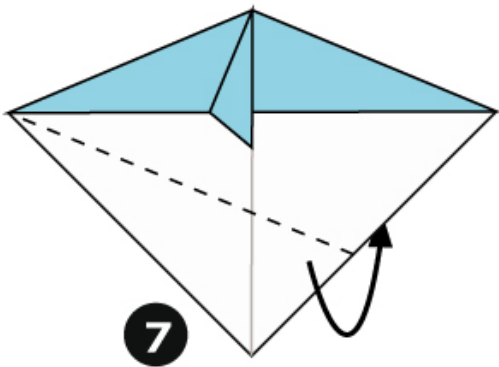
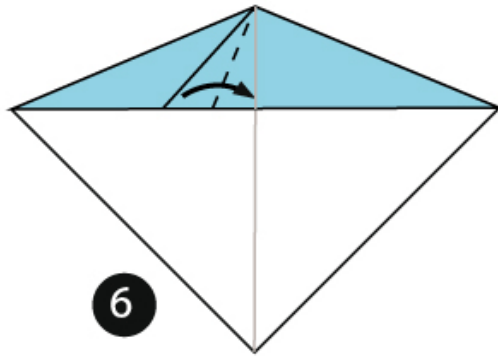
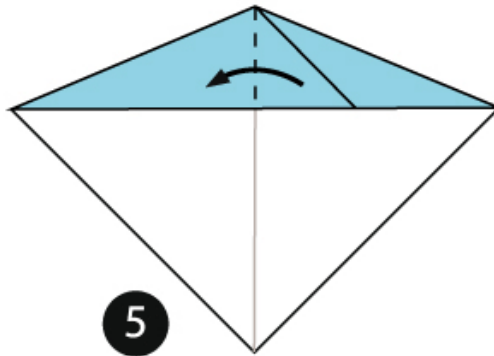
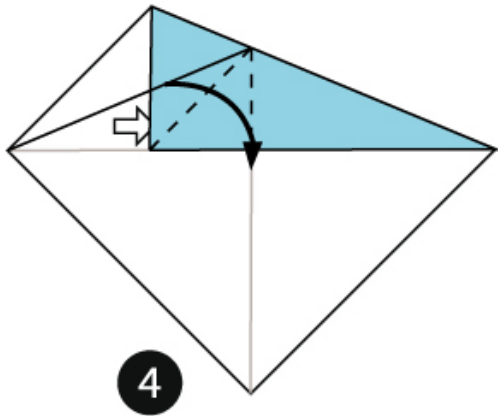
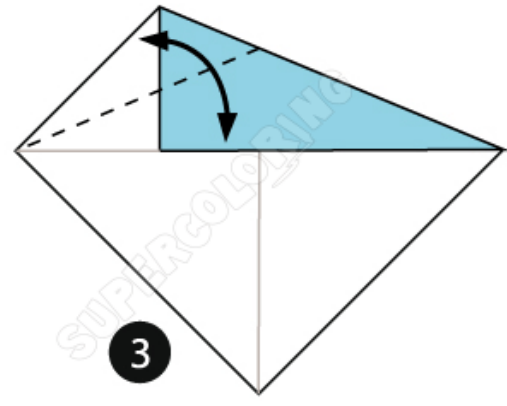
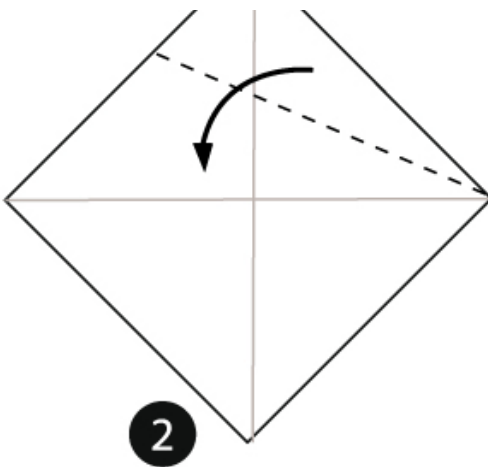
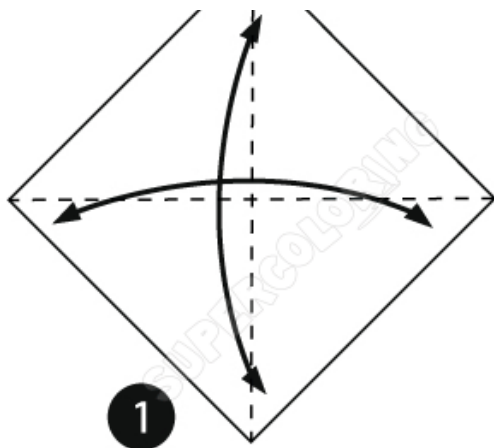

**WEEK # 2 CRAFT:  
ORIGAMI WHALE**

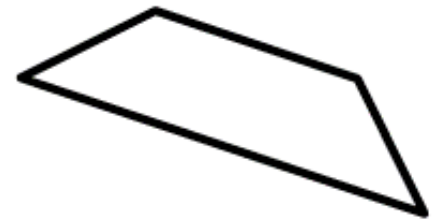
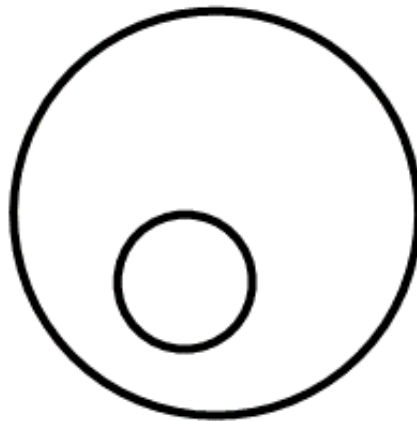
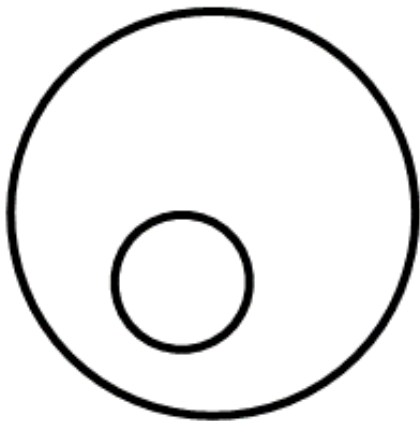
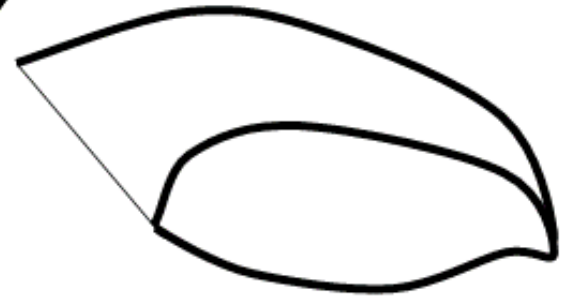
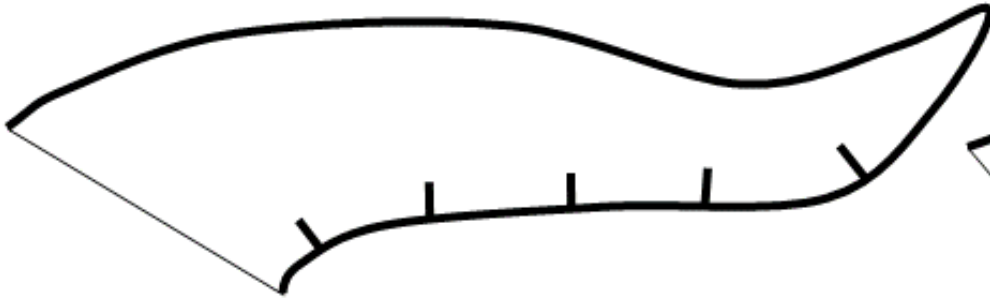
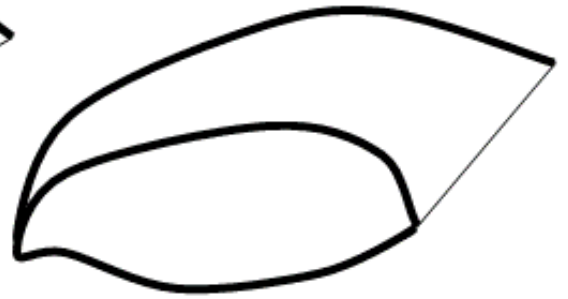
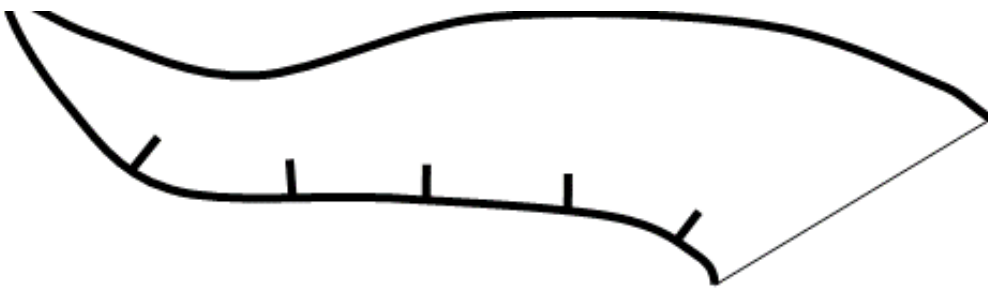

eyebrows

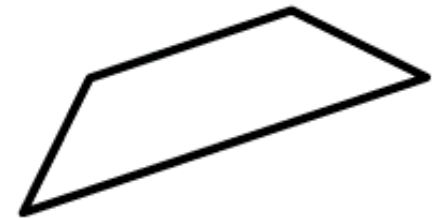

**WEEK # 3 CRAFT:  
GOAT PAPERPLATE**

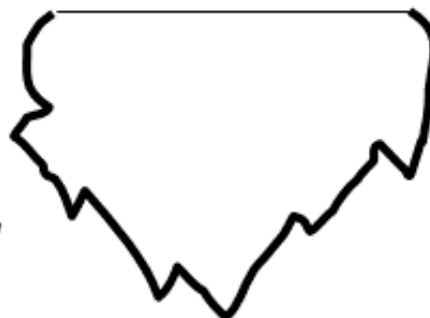

How it looks when finished



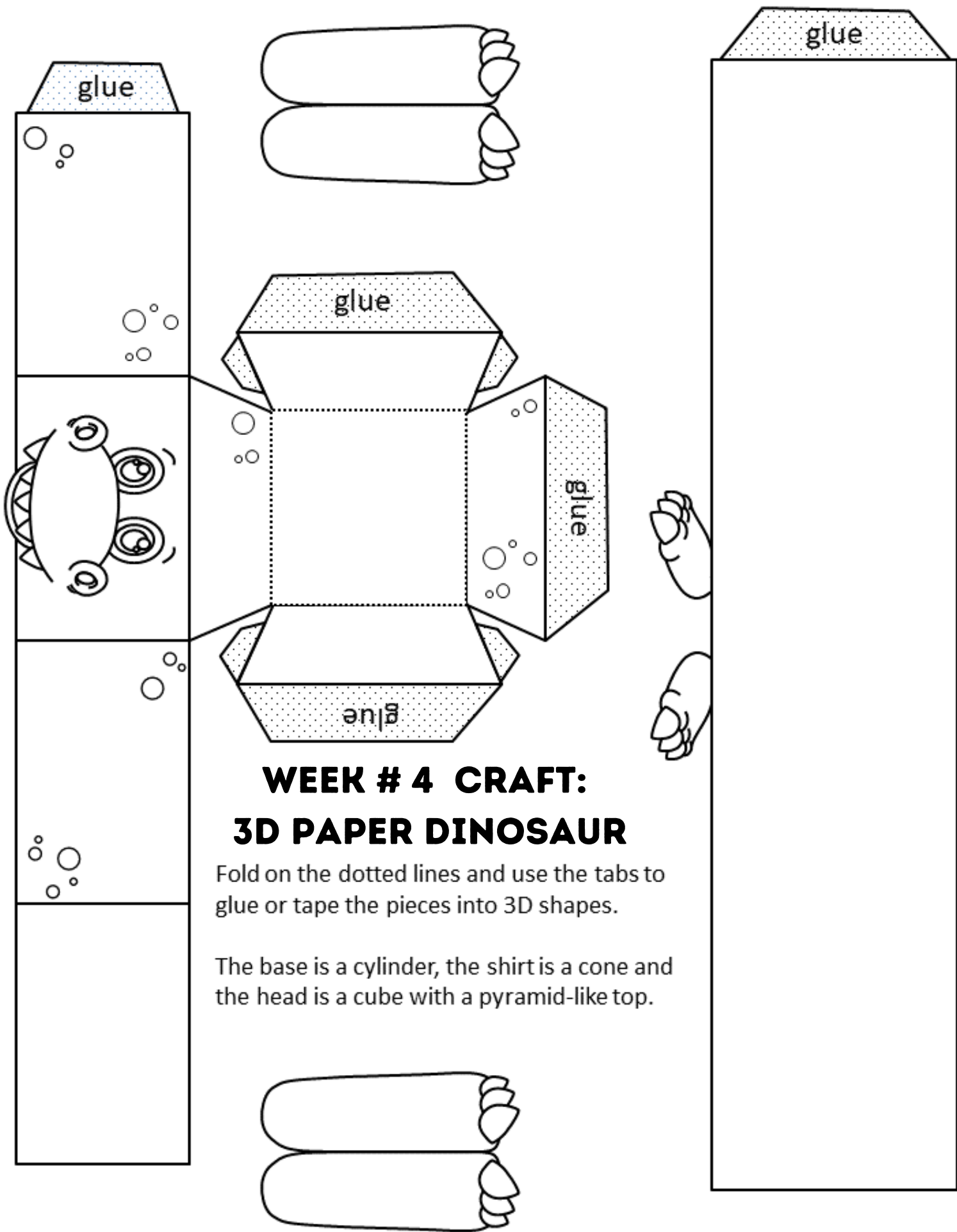

## WEEK # 4 CRAFT: 3D PAPER DINOSAUR

Fold on the dotted lines and use the tabs to glue or tape the pieces into 3D shapes.

The base is a cylinder, the shirt is a cone and the head is a cube with a pyramid-like top.



**WEEK # 4 CRAFT:  
3D PAPER DINOSAUR**

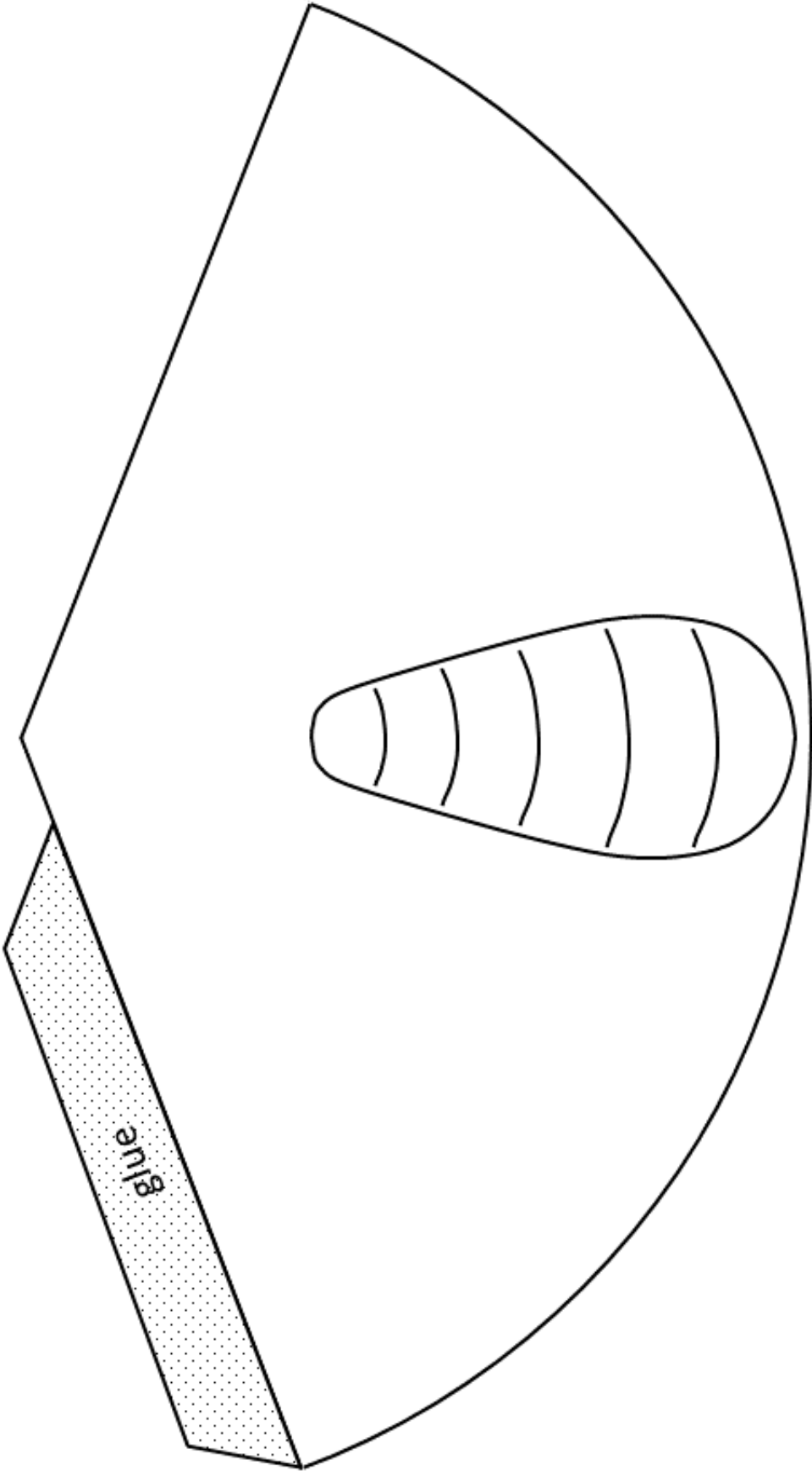

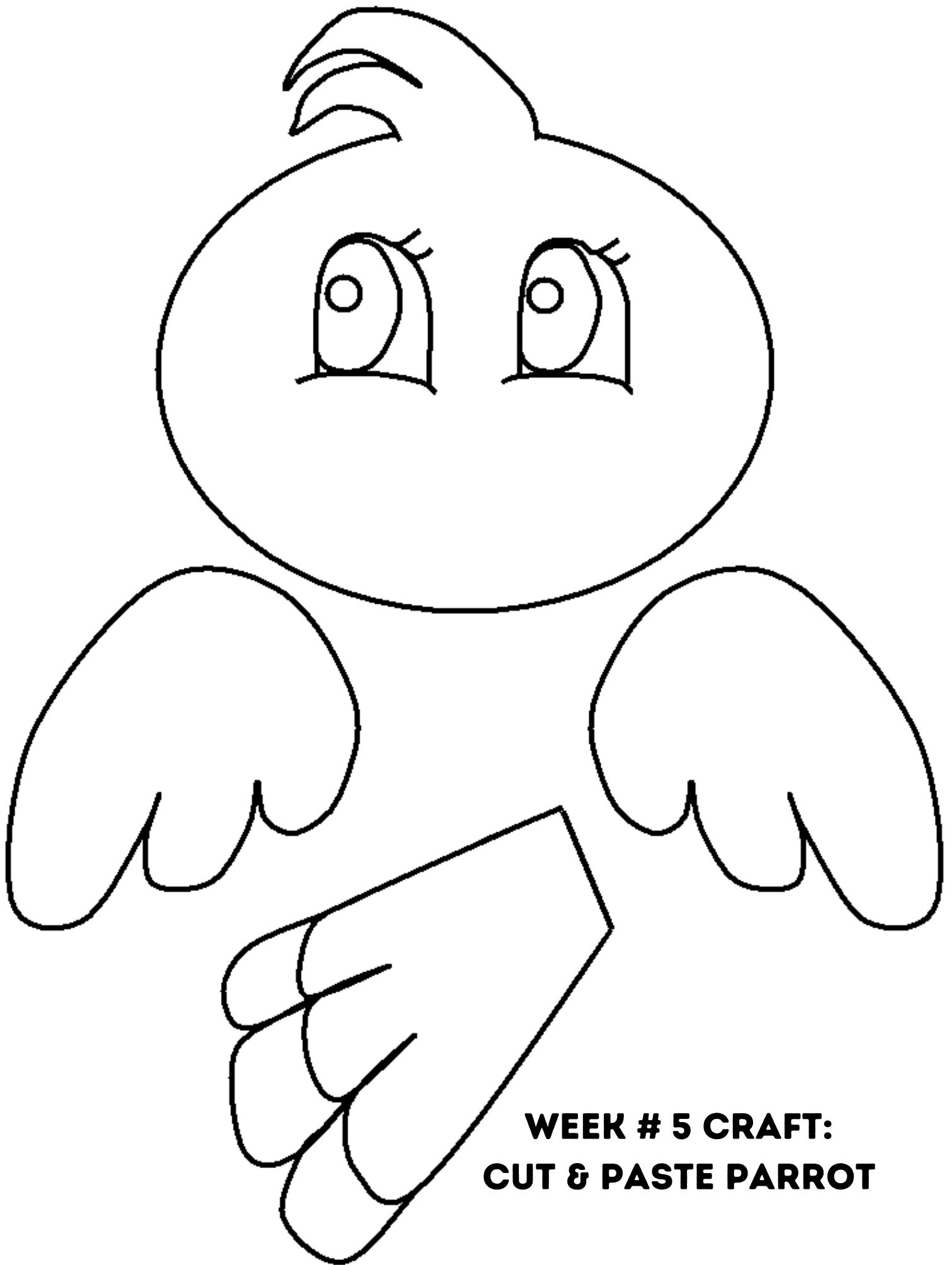

**WEEK # 5 CRAFT:  
CUT & PASTE PARROT**

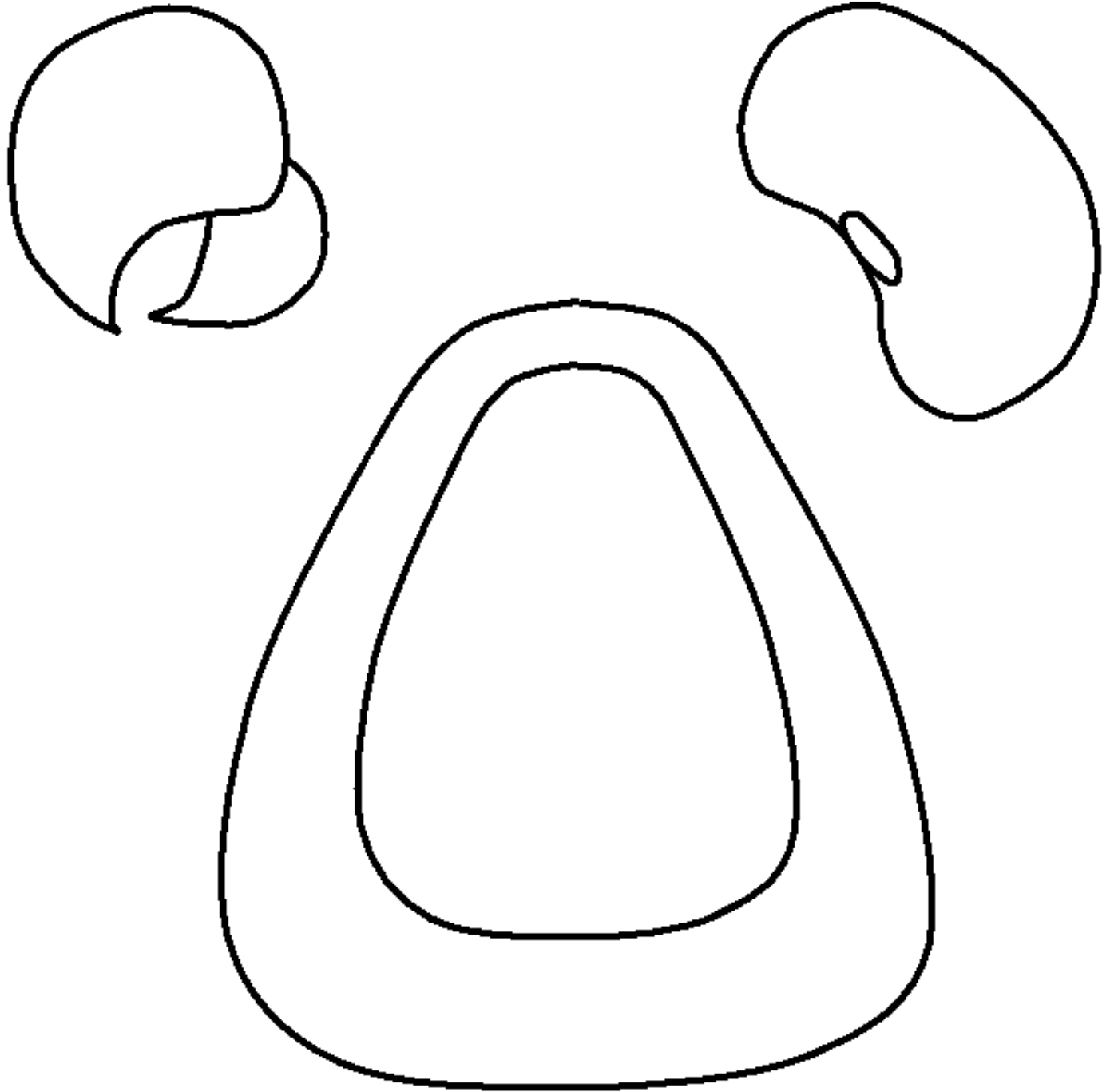

**WEEK # 5 CRAFT:  
CUT & PASTE PARROT**

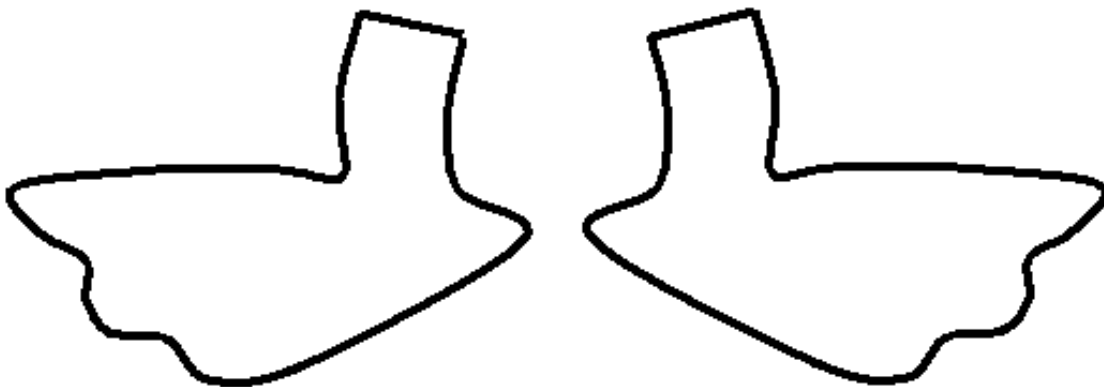

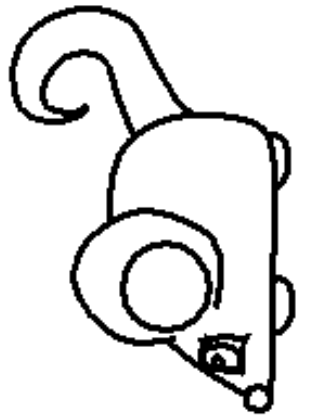
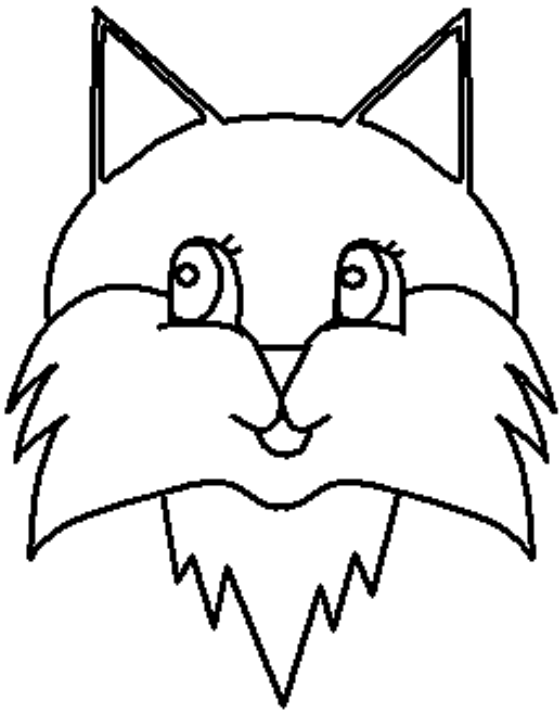
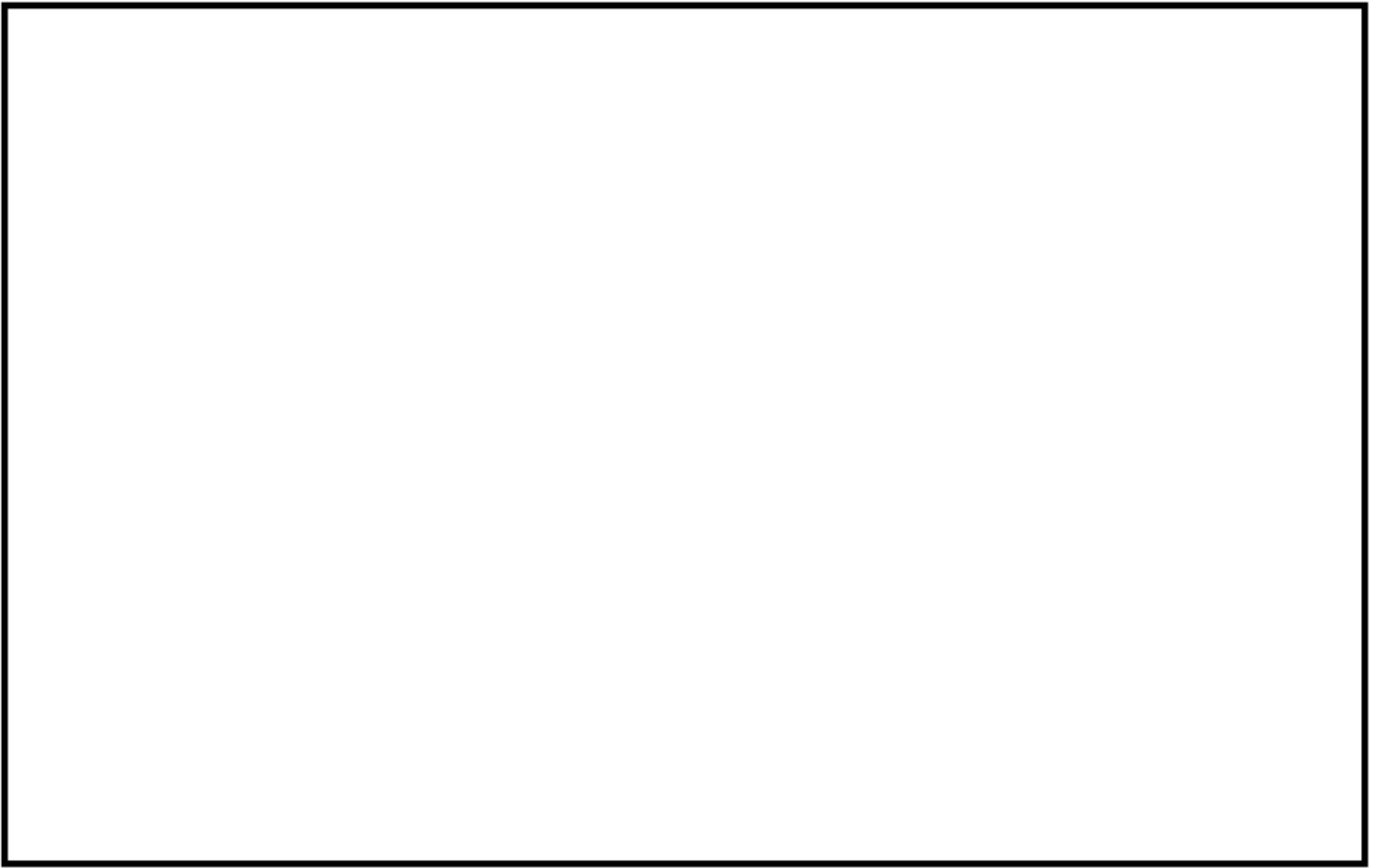

**WEEK # 6 CRAFT:  
TP ROLL FOX**

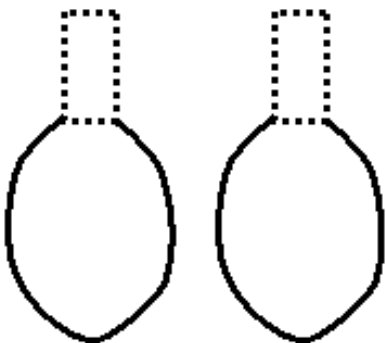
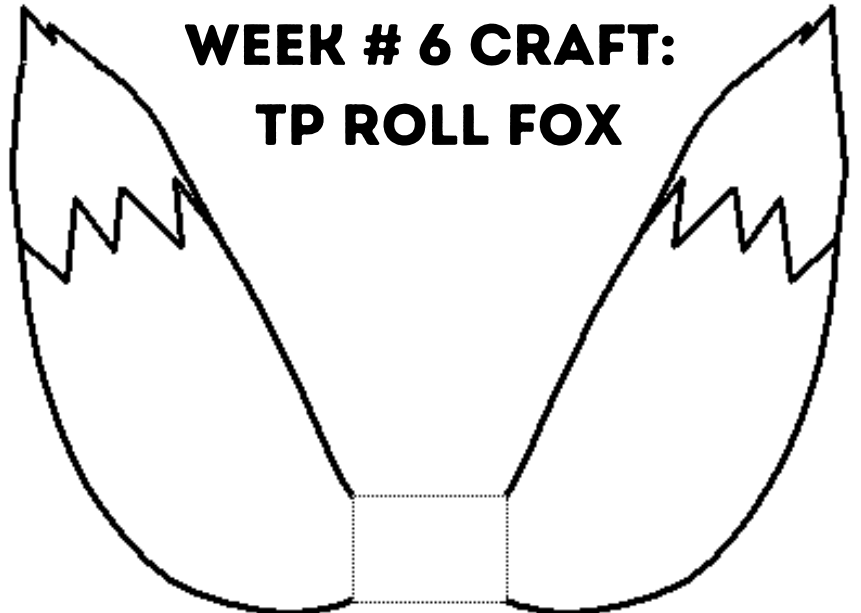

feet

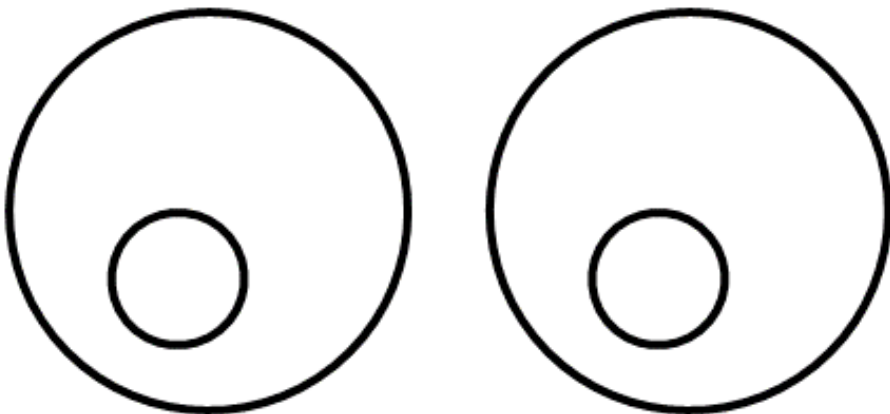
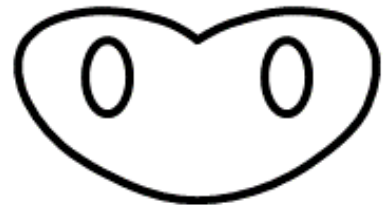
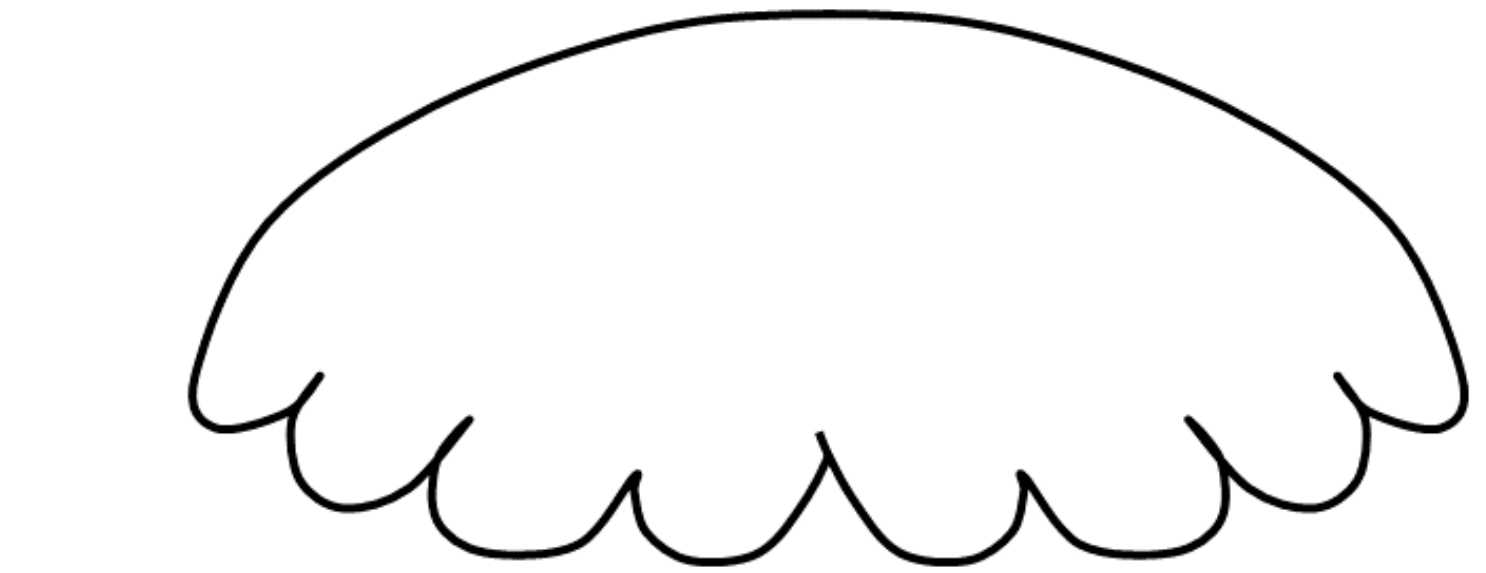

How it looks when finished

**WEEK # 7 CRAFT:  
WALRUS PAPERPLATE FACE**

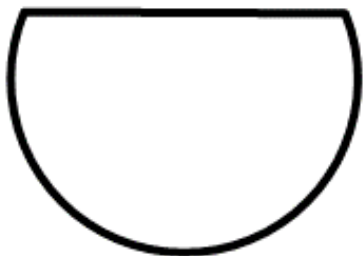

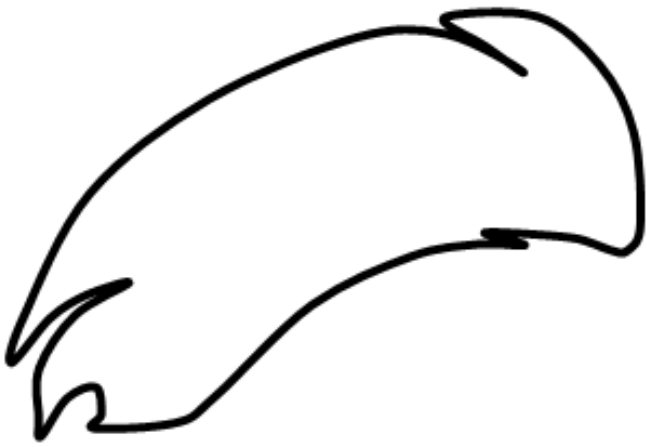

**WEEK # 7 CRAFT:  
WALRUS PAPERPLATE FACE**



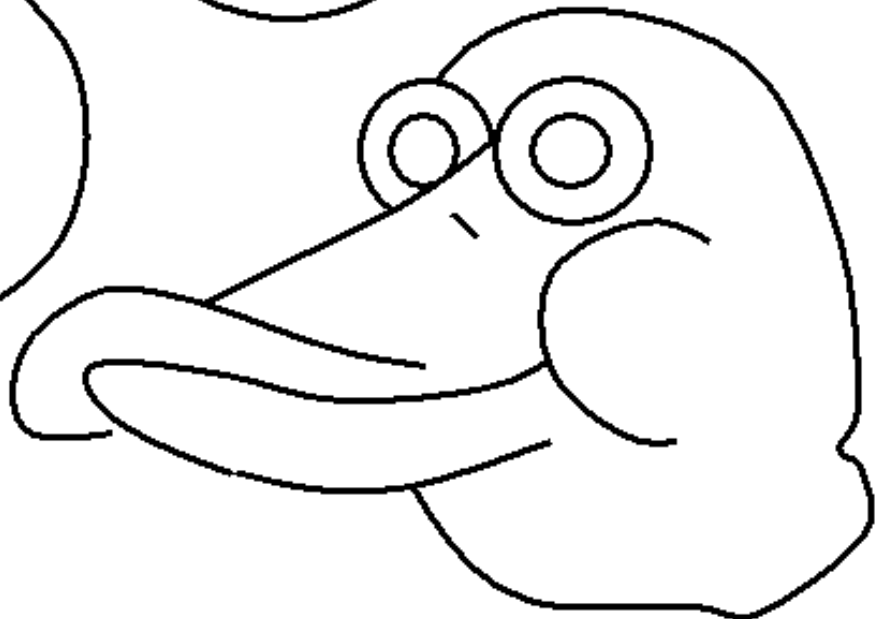
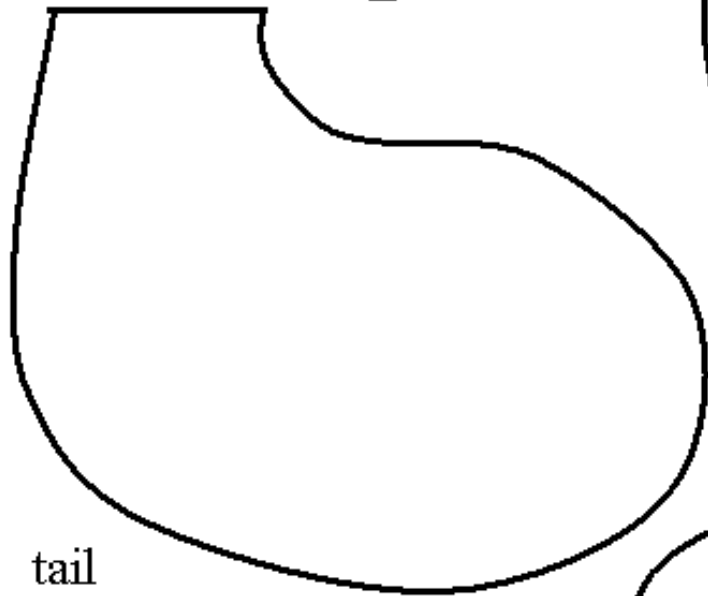
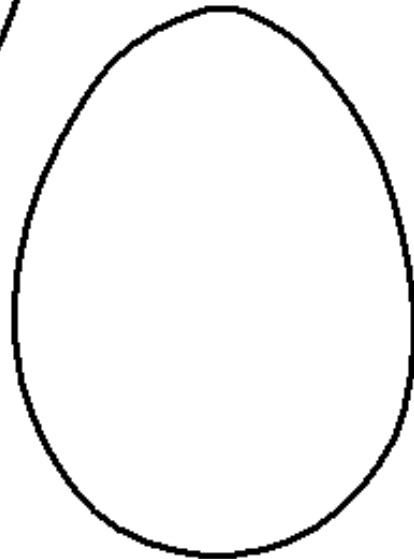
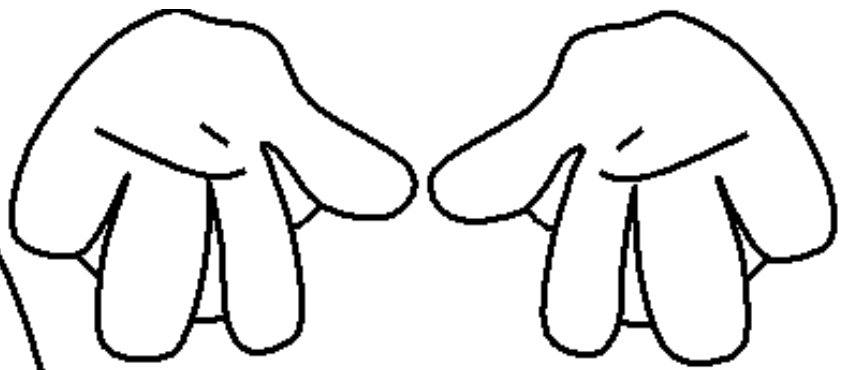
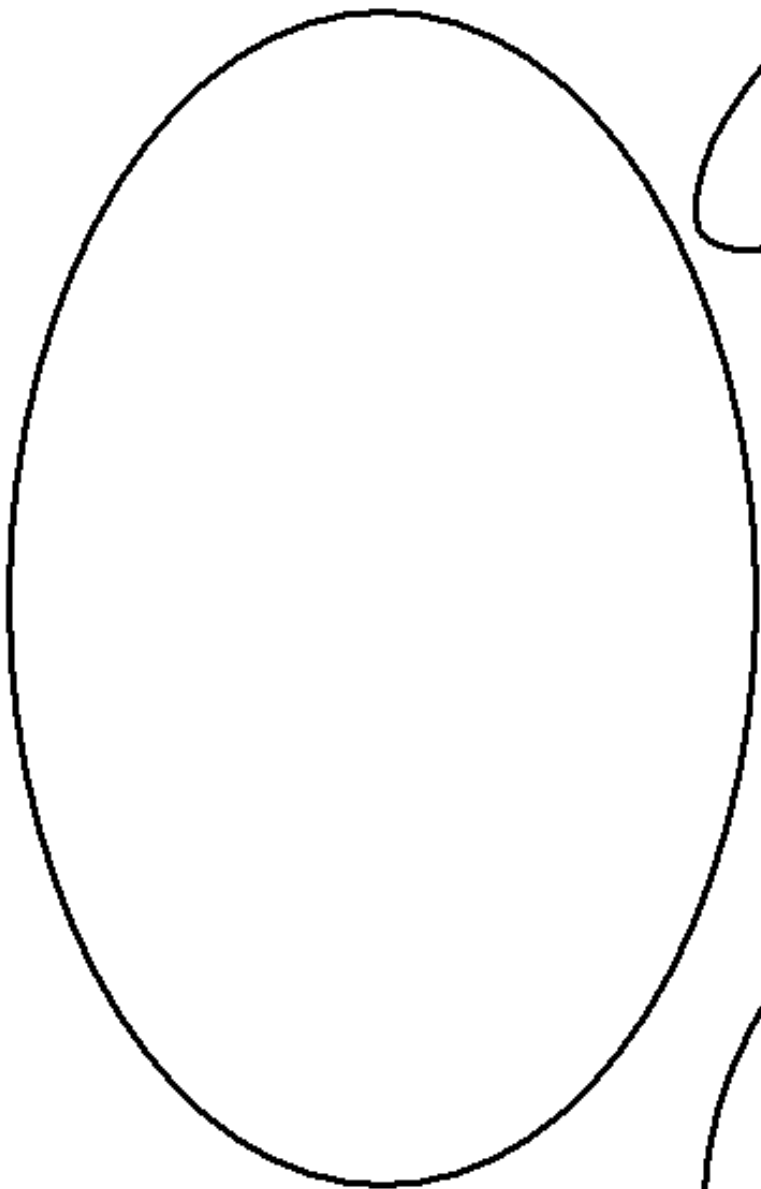

tail

**WEEK # 8 CRAFT:  
PLATYPUS WREATH**

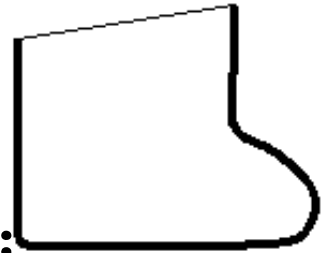
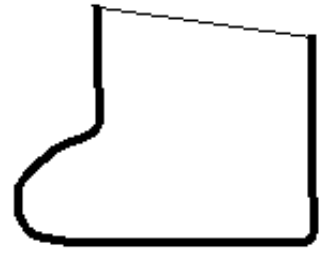
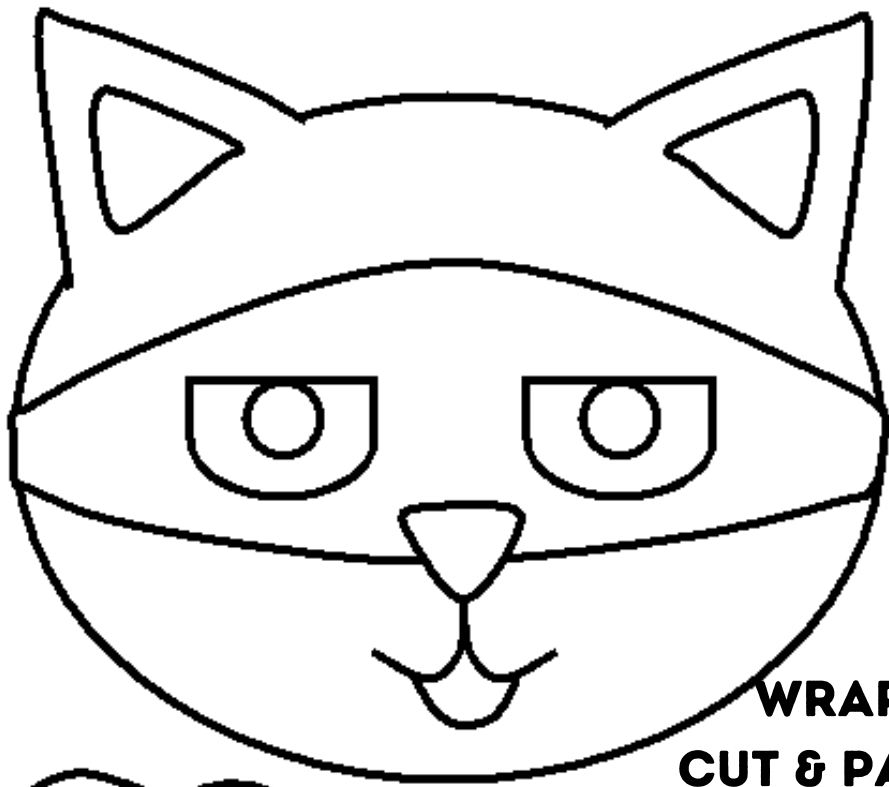

**WRAP-UP CRAFT:  
CUT & PASTE RACCOON**

